

Ceratti ¹⁹⁵⁴ SPA

Vito110/B

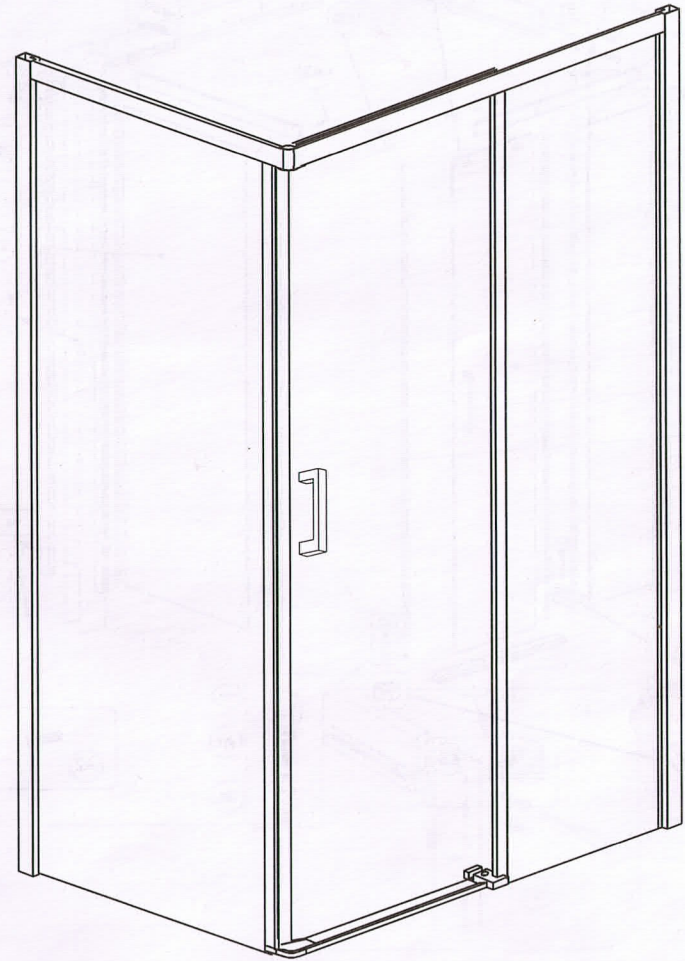

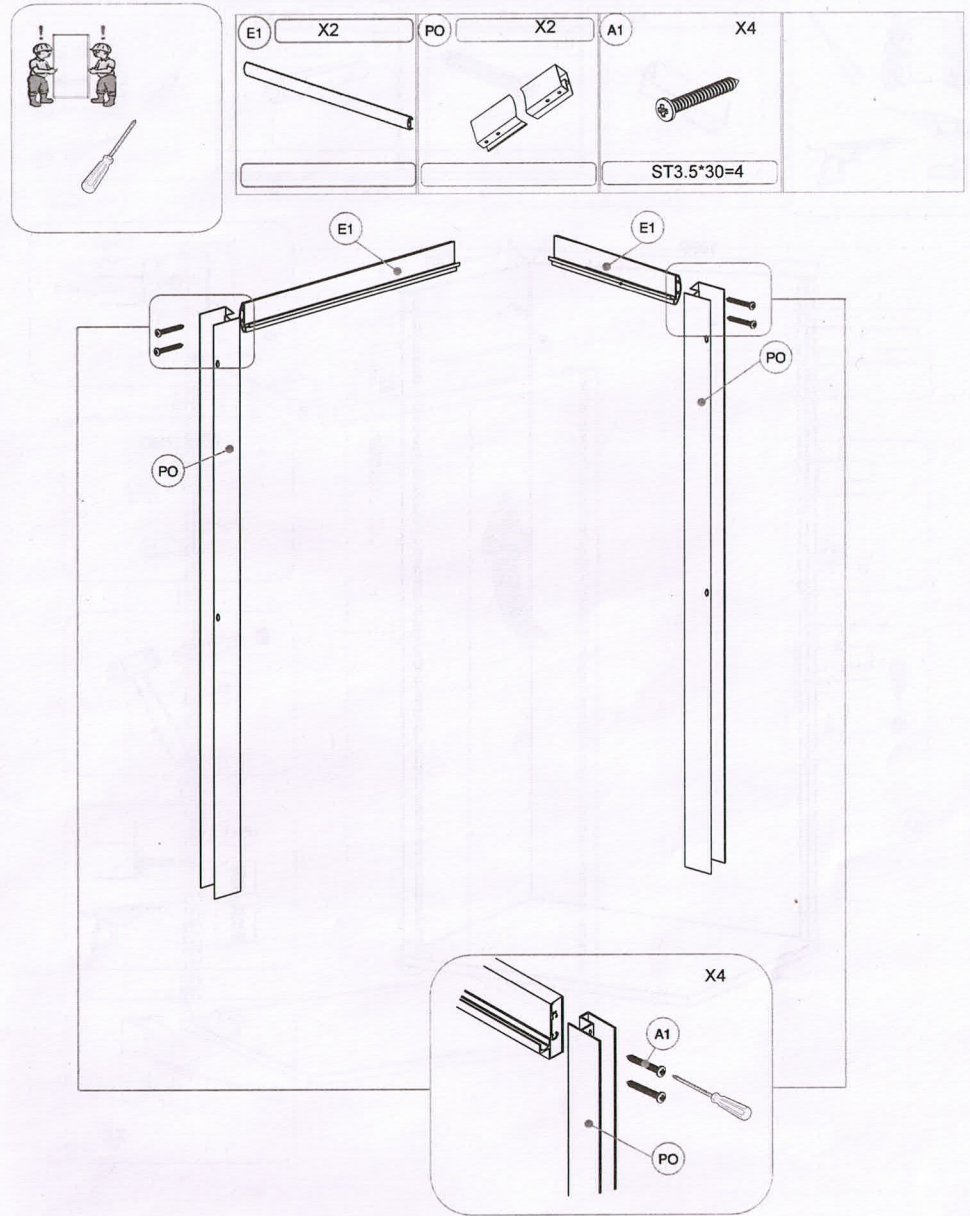

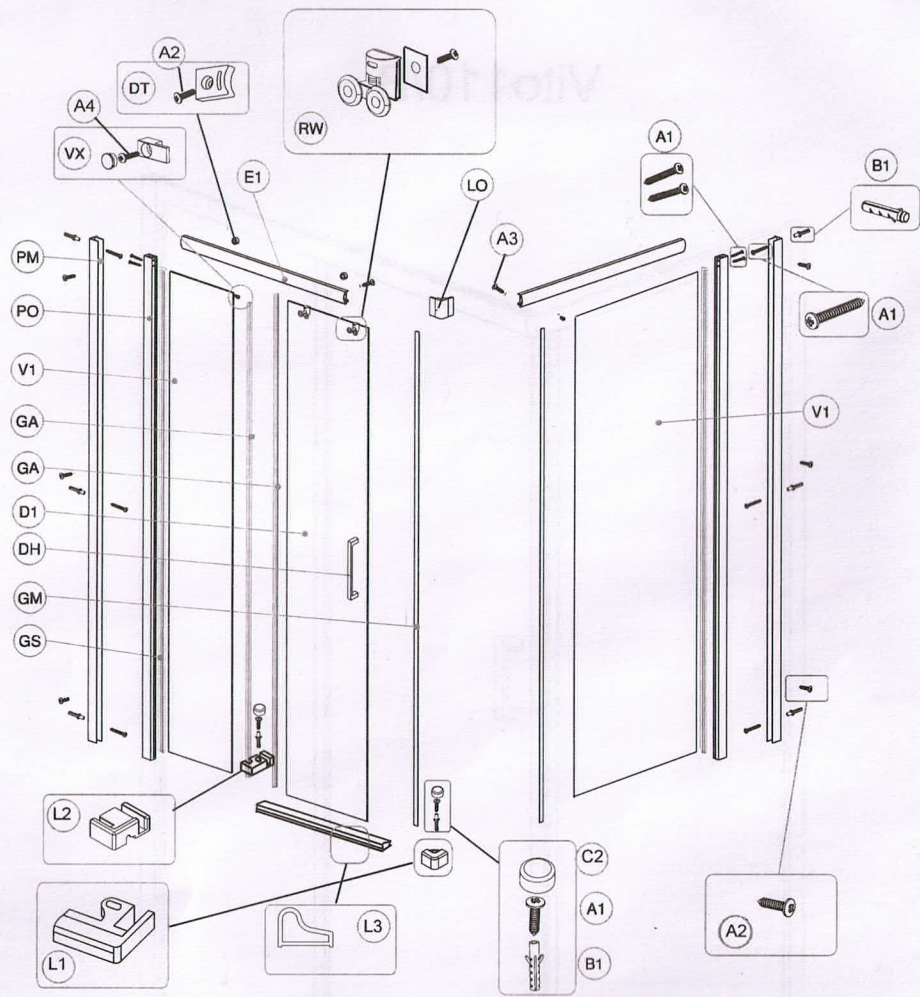

PM	X2	A1	ST4*30=6	B1	Ø6 X6

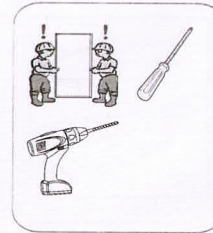
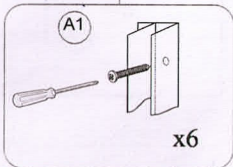
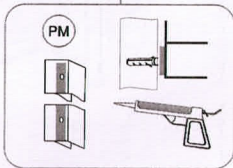
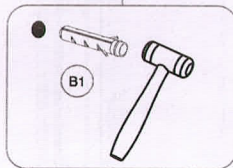
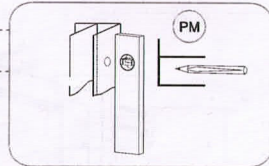
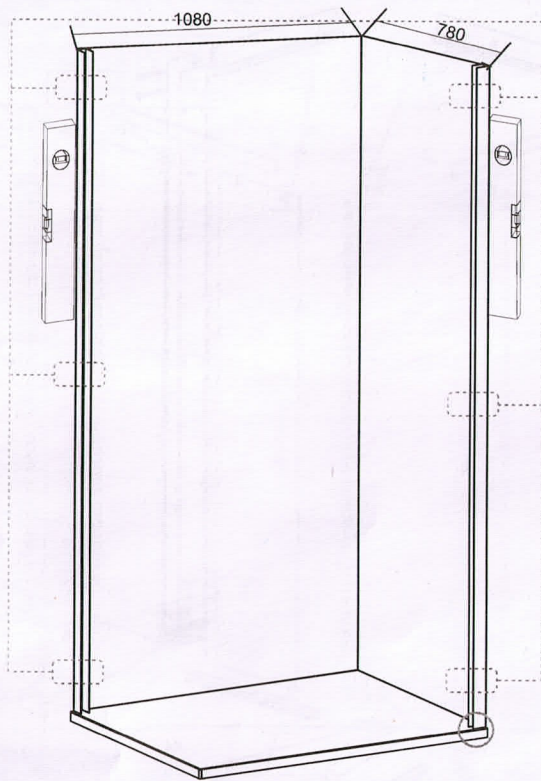

A2	X6	Ø 2.5	
* ST4X10			

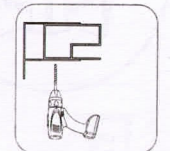
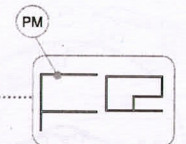
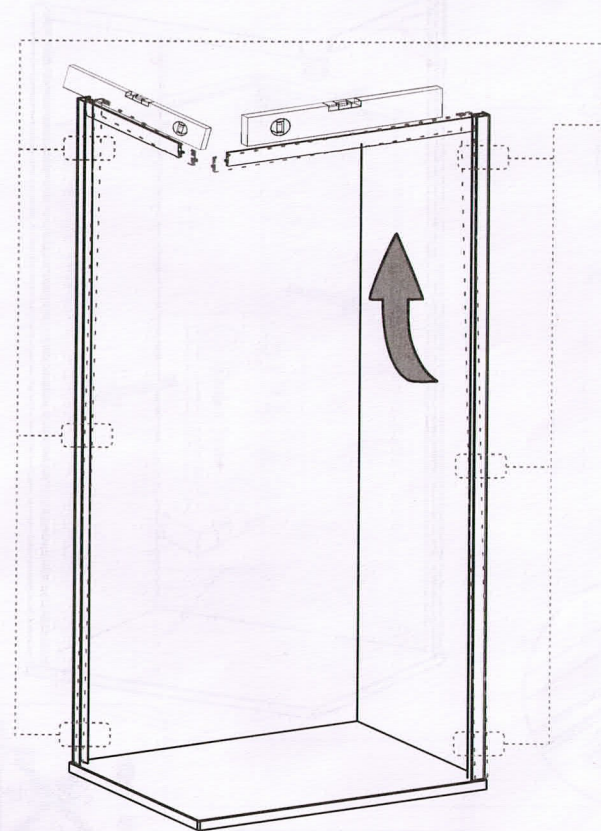

A2

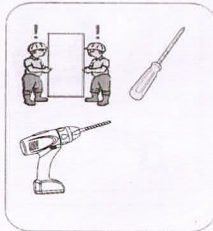

LO	X1
* A3 ST4X8	

$\varnothing 2,5$

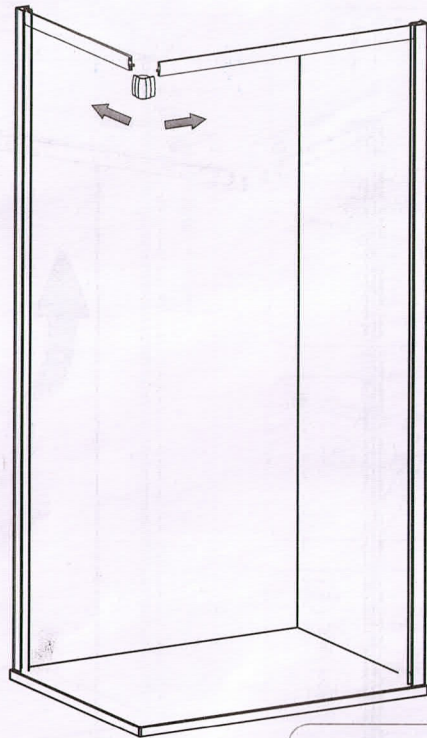
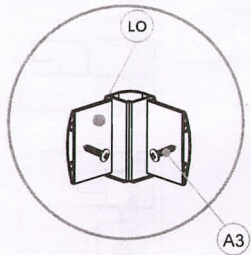

1cm

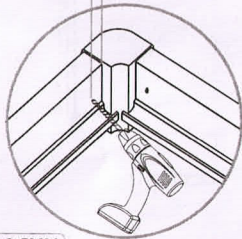

2.5MM

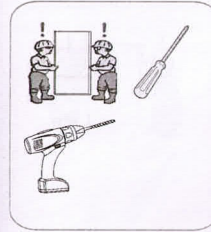
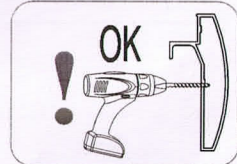
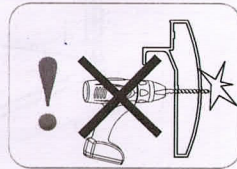
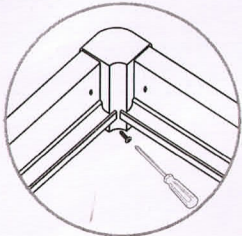

V1	X2

VX	X2
* ST4X14	

$\varnothing 2,5$

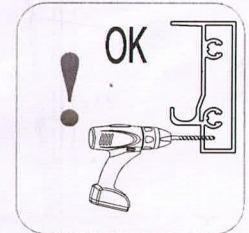
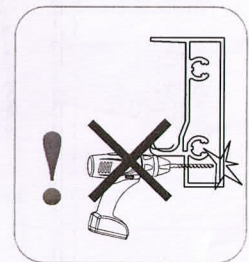
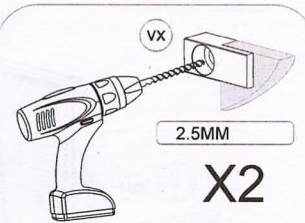
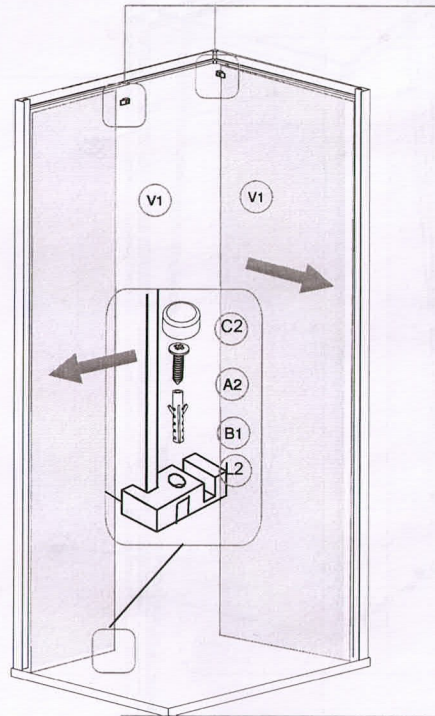
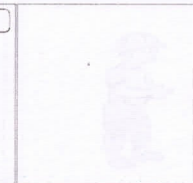

ST4X14
X2

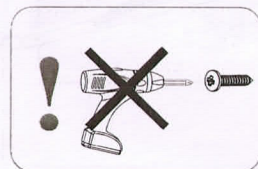

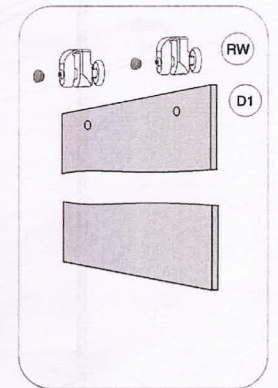
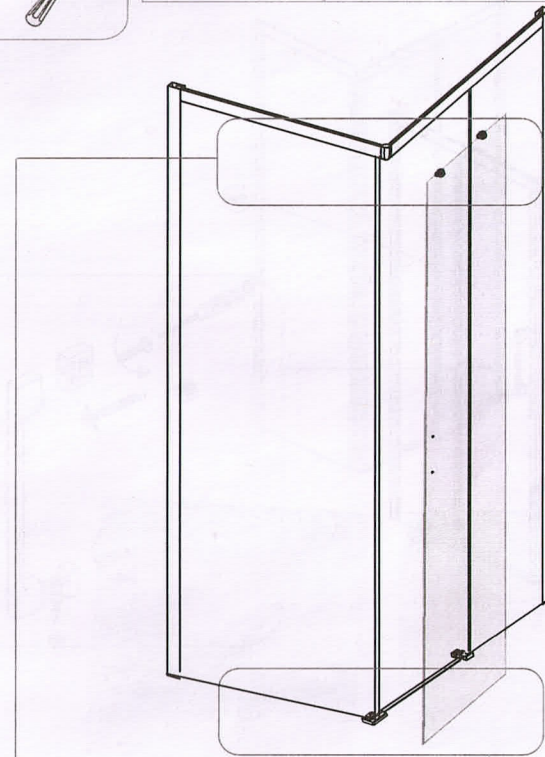
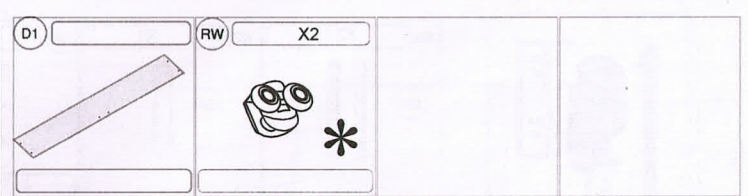
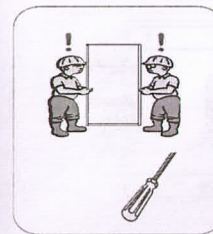
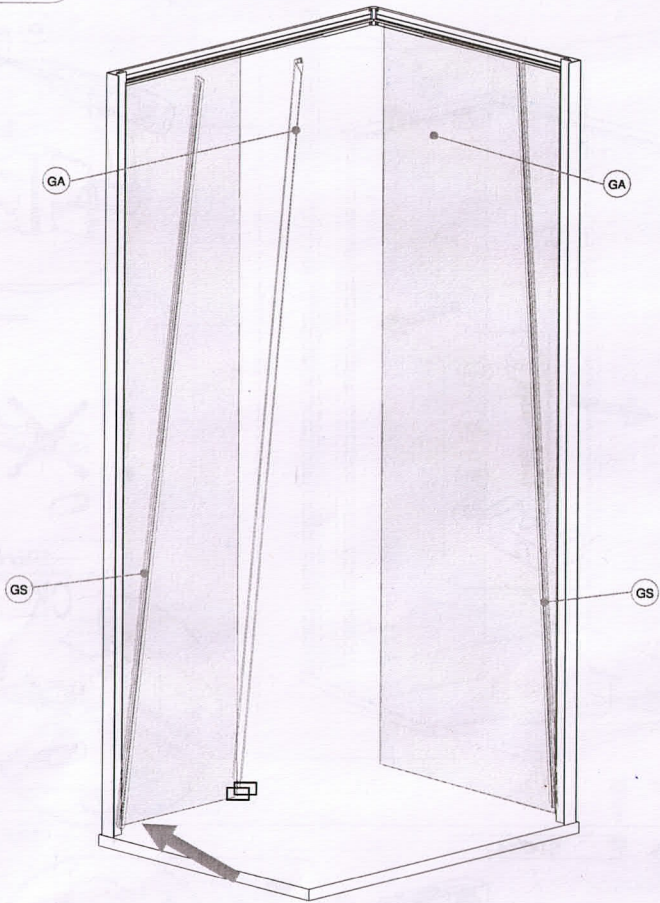
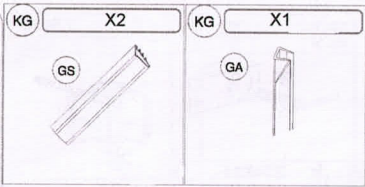

A19

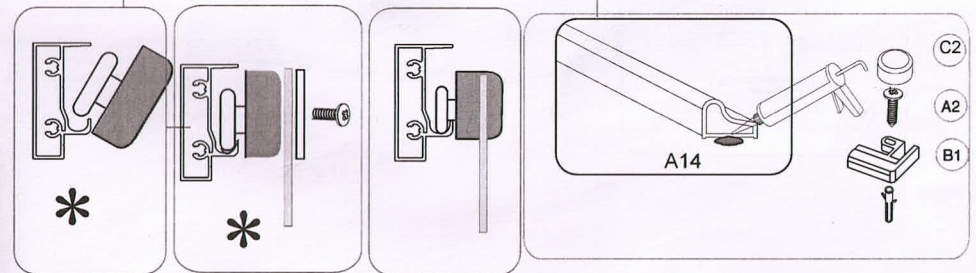



KG	X2	KG	X1	DH	X 1
GM		GA			L20

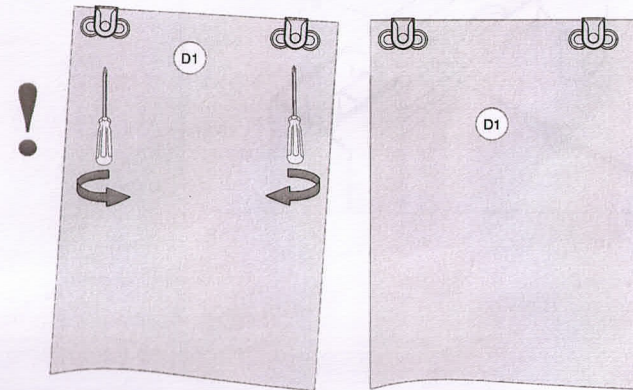
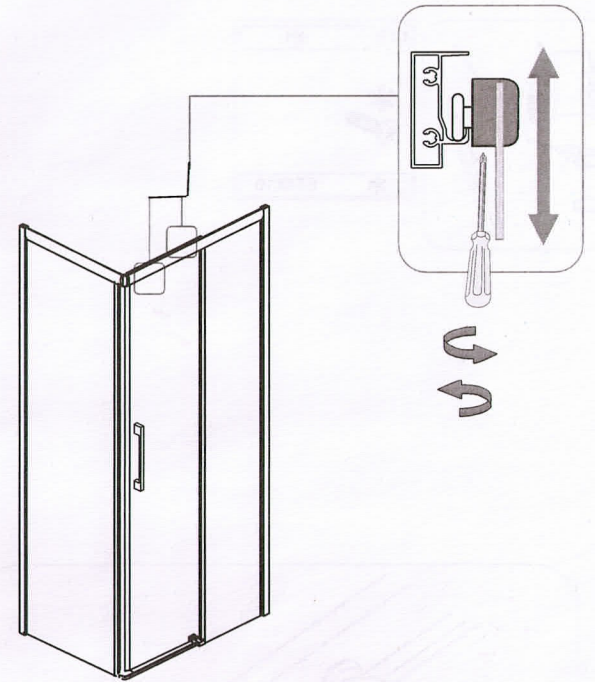
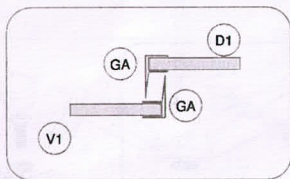
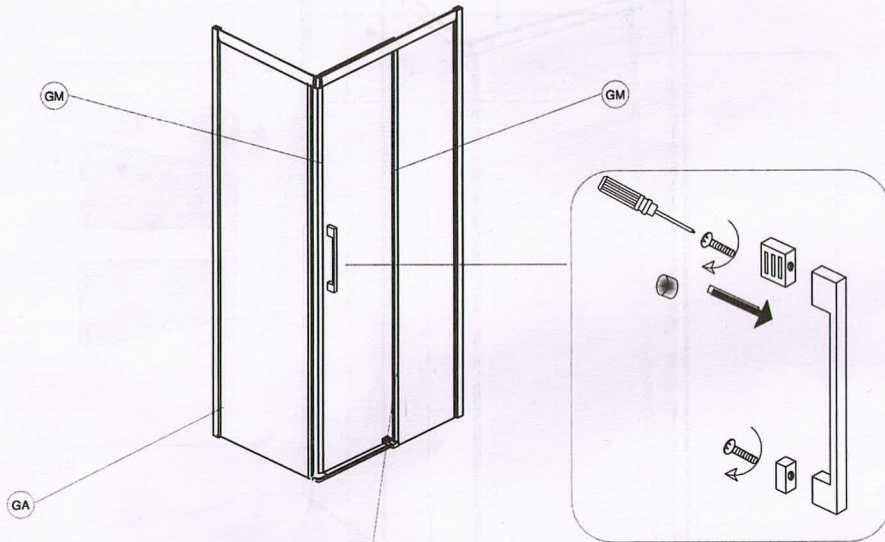

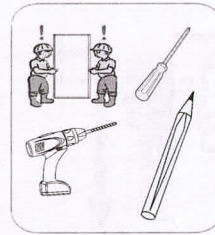

DT X1
*
* ST4X10

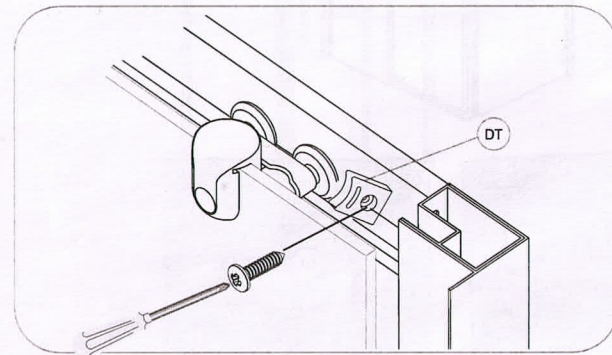
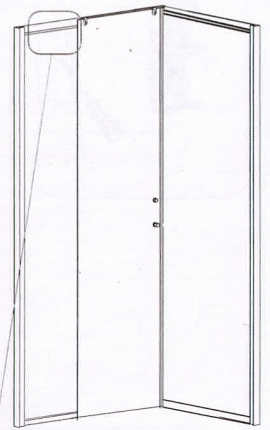

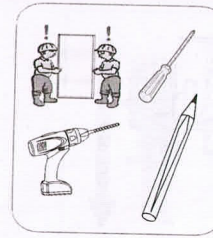

DT X1
*
* ST4X10

